

Panasonic®

AAC WMA MP3 CD Player/Receiver
Récepteur/lecteur CD avec lecture AAC/WMA/MP3
Reproductor de CD, AAC, WMA y MP3/receptor

Model: **CQ-C700U**

**AAC****WMA****MP3**

- Please read these instructions (including “Limited Warranty” and “Customer Services Directory”) carefully before using this product and keep this manual for future reference.
- Prière de lire attentivement ces instructions (y compris la “Garantie limitée” et le “Répertoire des services à la clientèle”) avant d'utiliser ce produit et conserver ce manuel d'utilisation pour s'y référer ultérieurement.
- Lea con atención estas instrucciones antes de utilizar el producto y guarde este manual para poderlo consultar en el futuro.

Safety Information

- Read the operating instructions for the unit and all other components of your car audio system carefully before using the system. They contain instructions about how to use the system in a safe and effective manner. Panasonic assumes no responsibility for any problems resulting from failure to observe the instructions given in this manual.

- This manual uses pictographs to show you how to use the product safely and to alert you to potential dangers resulting from improper connections and operations. The meanings of the pictographs are explained below. It is important that you fully understand the meanings of the pictographs in order to use this manual and the system properly.

 **Warning** This pictograph intends to alert you to the presence of important operating instructions and installation instructions. Failure to heed the instructions may result in severe injury or death.

 **Caution** This pictograph intends to alert you to the presence of important operating instructions and installation instructions. Failure to heed the instructions may result in injury or material damage.

Warning

Observe the following warnings when using this unit.

- The driver should neither watch the display nor operate the system while driving.**
Watching the display or operating the system will distract the driver from looking ahead of the vehicle and can cause accidents. Always stop the vehicle in a safe location and use the parking brake before watching the display or operating the system.
- Use the proper power supply.**
This product is designed for operation with a negative grounded 12 V DC battery system. Never operate this product with other battery systems, especially a 24 V DC battery system.
- Keep batteries and insulation film out of reach of infants.**
Batteries and insulation film can be ingested, so keep them out of the reach of infants. If an infant ingests a battery or insulation film, please seek immediate medical attention.
- Protect the Deck Mechanism.**
Do not insert any foreign objects into the slot of this unit.
- Do not disassemble or modify the unit.**
Do not disassemble, modify the unit or attempt to repair the product yourself. If the product needs to be repaired, consult your dealer or an authorized Panasonic Servicer.
- Do not use the unit when it is out of order.**
If the unit is out of order (no power, no sound) or in an abnormal state (has foreign objects in it, is exposed to water, is smoking, or smells), turn it off immediately and consult your dealer.
- The remote control unit should not lie about in the car.**
If the remote control unit lies about, it could fall on the floor while driving, get wedged under the brake pedal, and lead to a traffic accident.
- Refer fuse replacement to qualified service personnel.**
When the fuse blows out, eliminate the cause and have it replaced with the fuse prescribed for this unit by a qualified service engineer. Incorrect replacement of the fuse may lead to smoke, fire, and damage to the product.

Observe the following warnings when installing.

- Disconnect the lead from the negative (–) battery terminal before installation.**
Wiring and installation with the negative (–) battery terminal connected may cause electrical shock and injury due to a short circuit.
Some cars equipped with the electrical safety system have specific procedures of battery terminal disconnection.
FAILURE TO FOLLOW THE PROCEDURE MAY LEAD TO THE UNINTENDED ACTIVATION OF THE ELECTRICAL SAFETY SYSTEM RESULTING IN DAMAGE TO THE VEHICLE AND PERSONAL INJURY OR DEATH.
- Never use safety-related components for installation, grounding, and other such functions.**
Do not use safety-related vehicle components (fuel tank, brake, suspension, steering wheel, pedals, airbag, etc.) for wiring or fixing the product or its accessories.
- Installing the product on the air bag cover or in a location where it interferes with airbag operation is prohibited.**
- Check for piping, gasoline tank, electric wiring, and other items before installing the product.**
If you need to open a hole in the vehicle chassis to attach or wire the product, first check where the wire harness, gasoline tank, and electric wiring are located. Then open the hole from outside if possible.
- Never install the product in a location where it interferes with your field of vision.**
- Never have the power cord branched to supply other equipment with power.**
- After installation and wiring, you should check the normal operation of other electrical equipment.**
The continuation of their using in abnormal conditions may cause fire, electrical shock or a traffic accident.
- In the case of installation to an airbag equipped car, confirm warnings and cautions of the vehicle manufacturer before installation.**
- Make sure the leads do not interfere with driving or getting in and out of the vehicle.**
- Insulate all exposed wires to prevent short circuiting.**

Caution

Observe the following cautions when using this unit.

- ❑ **Keep the sound volume at an appropriate level.**
Keep the volume level low enough to be aware of road and traffic conditions while driving.
- ❑ **Do not insert or allow your hand or fingers to be caught in the unit.**
To prevent injury, do not get your hand or fingers caught in moving parts or in the disc slot. Especially watch out for infants.
- ❑ **This unit is designed for use exclusively in automobiles.**
- ❑ **Do not operate the unit for a prolonged period with the engine turned off.**
Operating the audio system for a long period of time with the engine turned off will drain the battery.
- ❑ **Do not expose the unit to direct sunlight or excessive heat.**
Otherwise these will raise the interior temperature of the unit, and it may lead to smoke, fire, or other damage to the unit.
- ❑ **Do not use the product where it is exposed to water, moisture, or dust.**
Exposure of the unit to water, moisture, or dust may lead to smoke, fire, or other damage to the unit. Make especially sure that the unit does not get wet in car washes or on rainy days.

Observe the following cautions when installing.

- ❑ **Refer wiring and installation to qualified service personnel.**
Installation of this unit requires special skills and experience. For maximum safety, have it installed by your dealer. Panasonic is not liable for any problems resulting from your own installation of the unit.
- ❑ **Follow the instructions to install and wire the product.**
Not following the instructions to properly install and wire the product could cause an accident or fire.
- ❑ **Take care not to damage the leads.**
When wiring, take care not to damage the leads. Prevent them from getting caught in the vehicle chassis, screws, and moving parts such as seat rails. Do not scratch, pull, bend or twist the leads. Do not run them near heat sources or place heavy objects on them. If leads must be run over sharp metal edges, protect the leads by winding them with vinyl tape or similar protection.
- ❑ **Use the designated parts and tools for installation.**
Use the supplied or designated parts and appropriate tools to install the product. The use of parts other than those supplied or designated may result in internal damage to the unit. Faulty installation may lead to an accident, a malfunction or fire.
- ❑ **Do not block the air vent or the cooling plate of the unit.**
Blocking these parts will cause the interior of the unit to overheat and will result in fire or other damage.

- ❑ **Do not install the product where it is exposed to strong vibrations or is unstable.**
Avoid slanted or strongly curved surfaces for installation. If the installation is not stable, the unit may fall down while driving and this can lead to an accident or injury.
- ❑ **Installation Angle**
The product should be installed in a horizontal position with the front end up at a convenient angle, but not more than 30°. The user should bear in mind that in some areas there may be restrictions on how and where this unit must be installed. Consult your dealer for further details.
- ❑ **Wear gloves for safety. Make sure that wiring is completed before installation.**
- ❑ **To prevent damage to the unit, do not connect the power connector until the whole wiring is completed.**
- ❑ **Do not connect more than one speaker to one set of speaker leads. (except for connecting to a tweeter)**

Observe the following cautions when handling the battery for the remote control unit.

- Use only specified battery (CR2025).
- Match the polarity of the battery with the (+) and (-) marks in the battery case.
- Replace dead battery as soon as possible.
- Remove the battery from the remote control unit when not using it for an extended period of time.
- Insulate the battery (by placing them in a plastic bag or covering them with vinyl tape) before disposal or storage.
- Dispose of the battery according to the local regulations.
- Do not disassemble, recharge, heat or short the battery. Do not throw a battery into a fire or water.

In case of battery leakage

- Thoroughly wipe the battery liquid off the battery case and insert new battery.
- If any part of your body or clothing comes into contact with battery liquid, wash it with plenty of water.
- If battery liquid comes into contact with your eyes, wash them with plenty of water and get immediate medical attention.

Safety Information (continued)

Caution

THIS PRODUCT IS A CLASS I LASER PRODUCT. USE OF CONTROLS OR ADJUSTMENTS OR PERFORMANCE OF PROCEDURES OTHER THAN THOSE SPECIFIED HEREIN MAY RESULT IN HAZARDOUS RADIATION EXPOSURE. DO NOT OPEN COVERS AND DO NOT REPAIR BY YOURSELF. REFER SERVICING TO QUALIFIED PERSONNEL.

The following applies only in the U.S.A.

Part 15 of the FCC Rules

FCC Warning:

Any unauthorized changes or modifications to this equipment would void the user's authority to operate this device.

Notice

This product contains a CR Coin Cell Lithium Battery which contains Perchlorate Material – special handling may apply.

See www.dtsc.ca.gov/hazardouswaste/perchlorate.

Before Reading These Instructions

Panasonic welcomes you to our constantly growing family of electronic products owners. We endeavor to give you the advantages of precise electronic and mechanical engineering, manufactured with carefully selected components, and assembled by people who are proud of the reputation their work has built for our company. We know this product will bring you many hours of enjoyment, and after you discover the quality, value and reliability we have built into it, you too will be proud to be a member of our family.

Before Reading These Instructions (continued)

Accessories

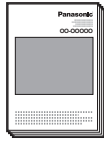

Operating Instructions

(YFM264C088CA)

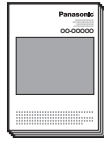

System Upgrade Guidebook

(YFM264C089CA)



Installation Instructions

(YFM294C133CA)



Product Registration Card

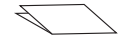

Customer Care Plan

Instruction kit

Q'ty: 1 set



Remote Control Unit (including a battery)
(CR2025)

(EUR7641010)

Q'ty: 1

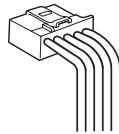

Power Connector

(YGAJ021009)

Q'ty: 1

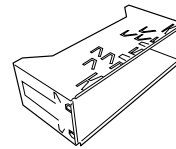

Mounting Collar

(FX0214C384ZB)

Q'ty: 1

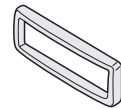

Trim Plate

(YEFC051013)

Q'ty: 1

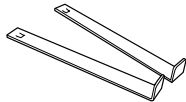

Lock Cancel Plate



Mounting Bolt



Tapping Screw

(5 mmø x 16 mm)



Hex. Nut

(5 mmø)

(YEP0FZ5739)

Q'ty: 1 set



Rear Support Strap

(YFG044C002ZA)

Q'ty: 1



Removable Face Plate Case

(YFC054C089CA)

Q'ty: 1

Notes:

- The number in parenthesis underneath each accessory part name is the part number for maintenance and service.
- Accessories and their parts numbers are subject to modification without prior notice due to improvements.
- Mounting Collar and Trim Plate are mounted on the main unit at shipment.

Before Reading These Instructions (continued)

U.S.A.

Obtain Product Information and Operating Assistance; locate your nearest Dealer or Servicenter; purchase Parts and Accessories; or make Customer Service and Literature requests by visiting our Web Site at:

<http://www.panasonic.com/support>

or, contact us via the web at:

<http://www.panasonic.com/contactinfo>

You may also contact us directly at:

1-800-211-PANA (7262),

Monday-Friday 9 am-9 pm; Saturday-Sunday 10 am-7 pm, EST.

For hearing or speech impaired TTY users,
TTY : 1-877-833-8855

Accessory Purchases:

Purchase Parts, Accessories and Instruction Books online for all Panasonic Products by visiting our Web Site at:

<http://www.pasc.panasonic.com>

or, send your request by E-mail to:

npcparts@panasonic.com

You may also contact us directly at:

1-800-332-5368 (Phone) 1-800-237-9080 (Fax Only)

(Monday-Friday 9 am to 8 pm, EST.)

Panasonic Services Company

20421 84th Avenue South, Kent, WA 98032

(We accept Visa, MasterCard, Discover Card, American Express, and Personal Checks)

For hearing or speech impaired TTY users,
TTY : 1-866-605-1277

Service in Puerto Rico

Matsushita Electric of Puerto Rico, Inc.

Panasonic Sales Company

Factory Servicenter:

Ave. 65 de Infantería, Km. 9.5, San Gabriel Industrial Park,

Carolina, Puerto Rico 00985

Phone (787) 750-4300, Fax (787) 768-2910

CANADA

WARRANTY SERVICE

FOR PRODUCT OPERATION ASSISTANCE, please contact:

Our Customer Care Centre:

Telephone #: (905) 624-5505

1-800 #: 1-800-561-5505

Fax #: (905) 238-2360

Email link: "Contact Us" on
www.panasonic.ca

FOR PRODUCT REPAIRS, please locate your nearest Authorized Servicentre at www.panasonic.ca:

Link : "Servicentres™ locator" under "Customer support"

IF YOU SHIP THE PRODUCT TO A SERVICENTRE

Carefully pack and send prepaid, adequately insured and preferably in the original carton.

Include details of the defect claimed, and proof of date of original purchase.

U.S.A.

PANASONIC CONSUMER ELECTRONICS COMPANY,
DIVISION OF MATSUSHITA ELECTRIC CORPORATION OF AMERICA
One Panasonic Way, Secaucus, New Jersey 07094

PANASONIC SALES COMPANY,
DIVISION OF MATSUSHITA ELECTRIC OF PUERTO RICO, INC.
Ave. 65 de infantería, Km. 9.5, San Gabriel Industrial Park
Carolina, Puerto Rico 00985

**PANASONIC AUTO PRODUCTS
LIMITED WARRANTY**

LIMITED WARRANTY COVERAGE

If your product does not work properly because of defects in materials and workmanship.

Panasonic Consumer Electronics Company or Panasonic Sales Company (collectively referred to as "the warrantor") will, for the length of the period indicated in the chart below, which starts with the date of original purchase ("warranty period"), at its option either (a) repair your product with new or refurbished parts, or (b) replace it with a new or refurbished product. The decision to repair or replace will be made by the warrantor.

| Categories | Parts | Labor |
|--|------------------|----------------|
| Audio Components (except items listed below) | One (1) Year | One (1) Year |
| MXE Series Audio Components (except items listed below) | Two (2) Years | Two (2) Years |
| Speakers Defective Car Audio Speakers under warranty must be exchanged at the place of purchase. Contact your Dealer for details. | One (1) Year | Not Applicable |
| Accessories (in exchange for defective items) | Ninety (90) Days | Not Applicable |

During the "Labor" warranty period, there will be no charge for labor. During the "Parts" warranty period, there will be no charge for parts. You must carry in or mail in your product prepaid during the warranty period. If non rechargeable batteries are included, they are not warranted. This warranty only applies to products purchased and serviced in the United States or Puerto Rico. This warranty is extended only to the original purchaser of a new product which was not sold "as is". A purchase receipt or other proof of the original purchase date is required for warranty service.

CARRY-IN OR MAIL-IN SERVICE

For Carry-In or Mail-In Service in the United States, call 1-800-211-PANA (7262) or visit

Panasonic Web Site: <http://www.panasonic.com>

For assistance in Puerto Rico, call Panasonic Sales Company (787)-750-4300 or fax (787)-768-2910.

LIMITED WARRANTY LIMITS AND EXCLUSIONS

This warranty ONLY COVERS failures due to defects in materials and workmanship, and DOES NOT COVER normal wear and tear or cosmetic damage. The warranty ALSO DOES NOT COVER damages which occurred during shipment, failures which are caused by products not supplied by the warrantor, failures which result from accident, misuse, abuse, neglect, bug infection, mishandling, misapplication, alteration, faulty installation, set-up adjustment, maladjustment of consumer control, improper maintenance, improper antenna, inadequate signal reception or pickup, power line surge, improper voltage supply, lightning, modification, commercial use (such as use in hotels, offices, restaurants, or other business uses) or rental use of the product, or service by anyone other than the technician from Factory Servicenter or other authorized service centers, or damage that is attributable to acts of God.

THERE ARE NO EXPRESS WARRANTIES EXCEPT AS LISTED UNDER "LIMITED WARRANTY COVERAGE". THE WARRANTOR IS NOT LIABLE FOR INCIDENTAL OR CONSEQUENTIAL DAMAGES RESULTING FROM THE USE OF THIS PRODUCT, OR ARISING OUT OF ANY BREACH OF THIS WARRANTY. (As examples, this excludes damages for lost time, cost of having someone remove or re-install an installed unit if applicable, travel to and from the sevicer, and loss

of media, data or other memory contents. The items listed are not exclusive, but are for illustration only.) **ALL EXPRESS AND IMPLIED WARRANTIES, INCLUDING THE WARRANTY OF MERCHANTABILITY, ARE LIMITED TO THE PERIOD OF THE LIMITED WARRANTY.**

Some states do not allow the exclusion or limitation of incidental or consequential damages, or limitations on how long an implied warranty lasts, so the exclusions may not apply to you.

This warranty gives you specific legal rights and you may also have other rights which vary from state to state. If a problem with this product develops during or after the warranty period, you may contact your dealer or Servicenter. If the problem is not handled to your satisfaction, then write to warrantor's Consumer Affairs Department at the addresses of the warrantor.

PARTS AND SERVICE WHICH ARE NOT COVERED BY THIS LIMITED WARRANTY ARE YOUR RESPONSIBILITY.

Customer's Record

Model
No. _____

Serial
No. _____

Dealer's
No. _____

Code
No. _____

Dealer's
Address _____

Date of
Purchase _____

CANADA

Panasonic Canada Inc.
5770 Ambler Drive, Mississauga Ontario L4W 2T3

PANASONIC PRODUCT LIMITED WARRANTY

Panasonic Canada Inc. warrants this product to be free from defects in materials and workmanship and agrees to remedy any such defect for a period as stated below from the date of original purchase.

CAR AUDIO PRODUCT – ONE (1) YEAR, PARTS AND LABOUR

(The labour to install or remove the product is not warranted)
ACCESSORIES - NINETY (90) DAYS, (IN EXCHANGE FOR DEFECTIVE ITEMS)

LIMITATIONS AND EXCLUSIONS

This warranty does not apply to products purchased outside Canada or to any product which has been improperly installed, subjected to usage for which the product was not designed, misused or abused, damaged during shipping, or which has been altered or repaired in any way that affects the reliability or detracts from the performance, nor does it cover any product which is used commercially. Dry cell batteries are also excluded from coverage under this warranty. This warranty is extended to the original end user purchaser only. A purchase receipt or other proof of the original purchase date is required before warranty service is performed.

THIS EXPRESS, LIMITED WARRANTY IS IN LIEU OF ALL OTHER WARRANTIES, EXPRESS OR IMPLIED, INCLUDING ANY IMPLIED WARRANTIES OF MERCHANTABILITY AND FITNESS FOR A PARTICULAR PURPOSE.

IN NO EVENT WILL PANASONIC CANADA INC. BE LIABLE FOR ANY SPECIAL, INDIRECT OR CONSEQUENTIAL DAMAGES.

In certain instances, some jurisdictions do not allow the exclusion or limitation of incidental or consequential damages, or the exclusion of implied warranties, so the above limitations and exclusions may not be applicable.

Features

Compatible with the AAC format

This unit has newly become compatible with AAC-formatted files in addition to the existing MP3 and WMA files.

Note: Some of AAC files (such as SD-Jukebox type) are not playable.

Hands-Free Phone System

Connection of the optional Hands-Free Phone System (Hands-Free Kit featuring *Bluetooth*[®] technology: CY-BT100U) allows users to talk on a handsfree cellular phone if the phone supports Bluetooth.

Note: This unit is designed **only for receiving calls**. It cannot send calls.

Bluetooth[®]

The Bluetooth word mark and logo are owned by the Bluetooth SIG, Inc. and any use of such marks by Matsushita Electric Industrial Co.,Ltd. is under license. Other trademarks and trade name are those of their respective owners.

Expansion Module (hub unit)

Connection of the Expansion Module (hub unit, CY-EM100U) allows users to connect up to 4 optional devices shown below. Even simultaneous connection of the Sirius Satellite Radio and XM Satellite Radio is feasible.

Note: A hub unit is not required to connect only one optional component.

Wide array of components for system upgrade

Various optional components allow users to obtain availability of wide range of system upgrade. Upgrading the system delivers relaxed AV space in a car. For further information, refer to the separate **System Upgrade Guidebook**.

- **DVD Changer**
The optional adapter (Conversion Cable for DVD/CD Changer: CA-CC30U) allows you to connect the optional Panasonic DVD changer unit (CX-DH801U).
- **CD Changer**
The optional adapter (Conversion Cable for DVD/CD Changer: CA-CC30U) allows you to connect the optional Panasonic CD changer unit (CX-DP880U).
- **iPod[®]**
The optional adapter (Direct Cable for iPod: CA-DC300U) allows you to connect the optional iPod series.
iPod is a trademark of Apple Computer, Inc., registered in the U.S. and other countries.
- **XM Satellite Radio**
You can connect the optional XM receiver (XMD-1000) with optional Digital Adapter. For details, refer to the operating instructions for the XM receiver.
- **Sirius Satellite Radio**
You can connect the optional Sirius Satellite radio receiver (SIR-PAN1).

Sound Control

SQ (Sound Quality)

You have six preset modes (FLAT, ROCK, POP, VOCAL, JAZZ, CLUB). You can customize your settings for these and save them for instant recall.

SQ7

This is 7-band equalizer with 60, 160, 400, 1 k, 3 k, 6 k, and 16 kHz. Each band is adjustable between -12 dB and 12 dB in steps of 2 dB.

D-M (Direct Memory)

You can assign your favorite broadcasting station to the **[D-M]** button. As the result of doing that, your favorite broadcasting station can be received even if the unit is in the CD mode or other modes. (⇒ page 20)

Customize

Initially stored moving images and still images are editable to taste. IMAGE STUDIO* allows you to process images from a digital camera or other devices without difficulty. (⇒ page 31)

* This software is downloadable from Panasonic Web site (<http://panasonic.co.jp/pas/en/software/customize/index.html>)



Contents

| | |
|----------------|----------|
| English | 2 |
| Français | 40 |
| Español | 78 |

Common

| | |
|--|-----------|
| ● Safety Information | 2 |
| ● Before Reading These Instructions | 4 |
| ● Features | 8 |
| ● Controls Layout | 10 |
| ● Preparation (Clock adjustment etc.) | 12 |
| ● General | 14 |
| ● Sound Control | 18 |

Each Source

| | |
|-----------------------------|-----------|
| ● Radio | 20 |
| ● CD Player | 22 |
| ● MP3/WMA/AAC Player | 24 |

As Needed

| | |
|--|-----------|
| ● Audio Setting | 28 |
| ● Function Setting (Security Function Setting etc.) | 29 |
| ● Display Setting | 30 |
| ● Customize the Display (Customize Function) | 31 |
| ● Troubleshooting | 33 |
| ● Error Display Messages | 37 |
| ● Notes on Discs | 38 |
| ● Maintenance/Fuse | 38 |
| ● Specifications | 39 |

Controls Layout

Note: This instruction manual explains operations for use with the buttons on the main unit. (Different operations excluded)

Main Unit

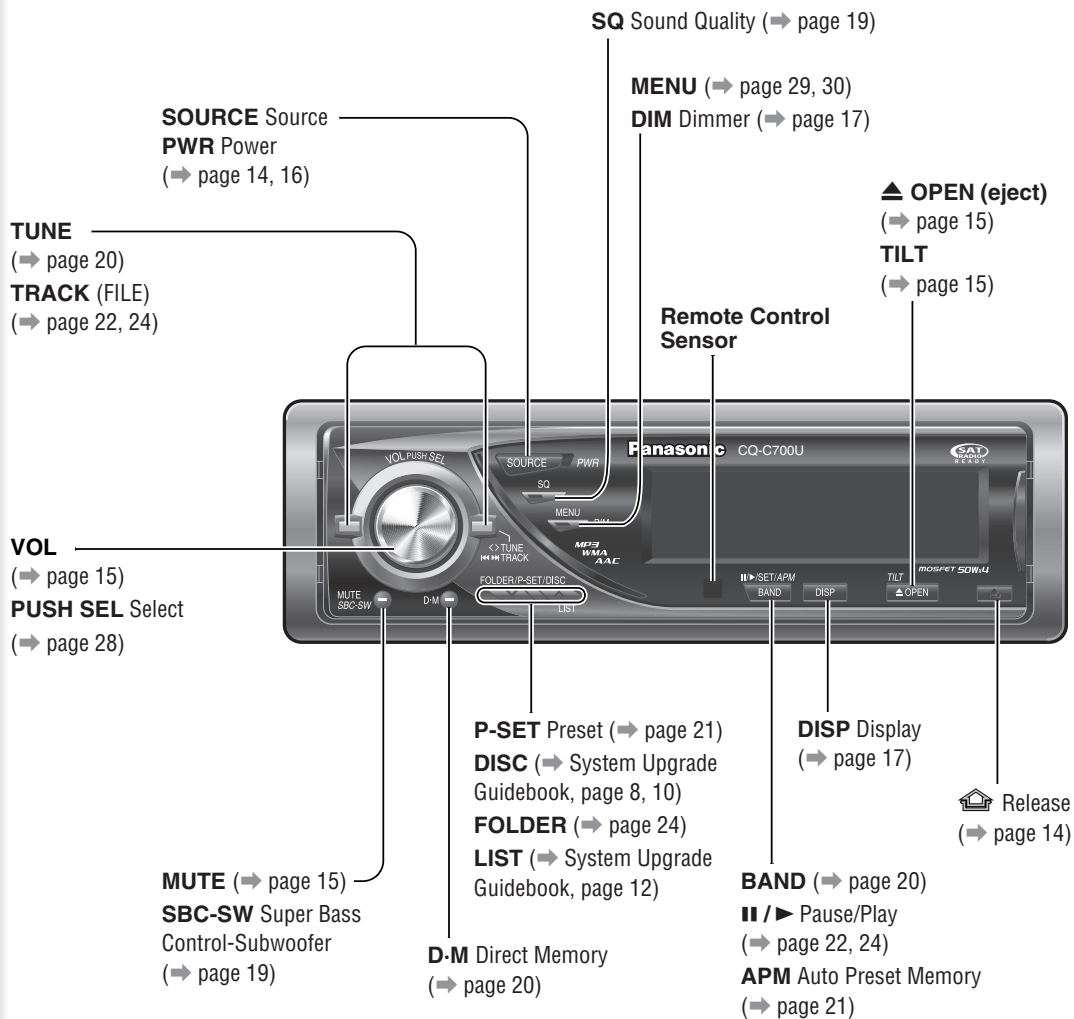

When Face Plate Opens

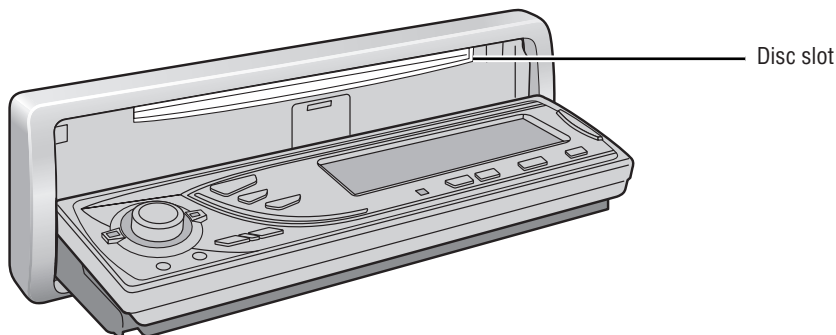

Number Buttons

0 — 9 > 0 to 9

NUMBER

RANDOM 4

SCAN 5

REPEAT 6

< 7 9 >

TUNE TRACK (FILE)

8 0

P-SET (Preset)
DISC (FOLDER)

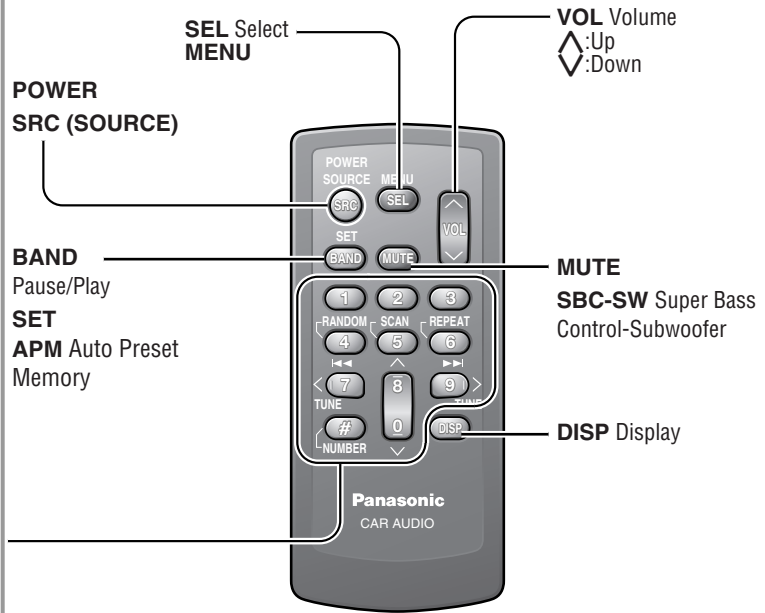

Although most of the functions of this unit are executable with both the main unit and remote control, the following functions are excluded.

Operations executable only with main unit

- Face panel's opening, closing, tilting, and removal actions (⇒ page 15)
- Disc ejection (⇒ page 15)
- Dimmer (⇒ page 17)
- SQ on, off, and adjustment (⇒ page 19)
- Direct memory setting and calling (⇒ page 20)

Operations executable only with remote control

- Preset station calling with one-touch operation (⇒ page 21)
- Direct access to tracks on CDs (⇒ page 23, 25)
- Random and repeat play with one-touch operation (⇒ page 23, 25)
- Scan playback (⇒ page 23, 25)

Preparation

Cancellation of demonstration screen

For the first use, the following screen may appear repeatedly.

- 1 Set your car's ignition switch to the ACC or On position.

The demonstration screen appears.



- 2 Press [SOURCE] (PWR: POWER).
- 3 Press [MENU] to display the menu display.

For using the remote control, hold down [SEL] (MENU) for 2 sec. or more.

- 4 Press [<] or [>] to display the DISPLAY menu.

- 5 Turn [VOL] to select "DEMONSTRATION".

For using the remote control, use [^] or [v].



- 6 Press [PUSH SEL] to select "OFF".

For using the remote control, use [BAND] (SET).

- 7 Press [MENU] to close the menu screen.

For using the remote control, hold down [SEL] (MENU) for 2 sec. or more.

Note: This unit is operable as usual even if the demonstration screen is activated. The demonstration screen automatically appears if no operation is executed for 1 minute.

Preparation Before Initial Use

Pull the insulation film out from the backside of remote control gently.

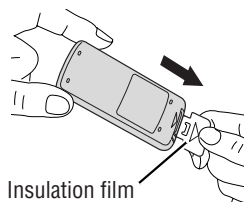

Insulation film

Battery Replacement

- 1 Remove the battery holder with the remote control unit placed on a flat surface.

- 1 Stick your thumbnail into the groove, and push the holder in the direction of the arrow, and at the same time.

- 2 Pull it out in the direction of the arrow using a tough pointed object.

Tough pointed object

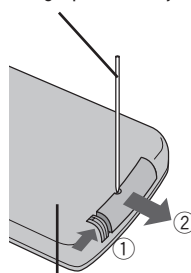

Back side

- 2 Put a battery in the case with (+) side facing up.
- 3 Put the case back.

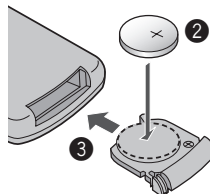

Warning

Keep batteries and insulation film out of reach of infants. If an infant ingests a battery, please seek immediate medical attention.

Cautions

- Remove and dispose of an old battery immediately.
- Do not disassemble, heat or short a battery. Do not throw a battery into a fire or water.
- Follow local regulations when disposing of a battery.
- Improper use of a battery may cause overheating, an explosion or ignition, resulting in injury or a fire.

Notice

This product contains a CR Coin Cell Lithium Battery which contains Perchlorate Material – special handling may apply.
See www.dtsc.ca.gov/hazardouswaste/perchlorate.

Note: Battery Information:

Battery Type: Panasonic lithium battery (CR2025)
(Included in the remote control)

Battery Life: Approximately 6 months under normal use
(at room temperature)

The following functions are activated when the Security Function is ON. (⇒ page 29)

- The security indicator lights up when removing the face plate.

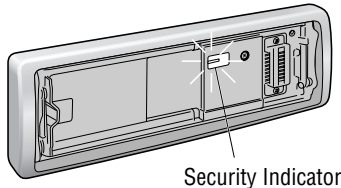

- The alarm sounds and the message appears on the screen to warn you to remove the face plate at ACC off.



You may need to set the following depending on the devices to be connected.

Using Subwoofer

- Subwoofer level adjustment (⇒ page 28)
- Subwoofer low pass filter (⇒ page 28)

Note: Other settings are required when a Sirius receiver, an XM receiver, or a Hands-Free Phone System is connected. (⇒ System Upgrade Guidebook)

Note: Adjust the clock when "ADJUST" appears on the display.

- 1 Press **[MENU]** to display the menu display.
For using the remote control, hold down **[SEL] (MENU)** for 2 sec. or more.
- 2 Press **[<]** or **[>]** to display the DISPLAY menu.
- 3 Turn **[VOL]** to select "CLOCK ADJ".
For using the remote control, use **[^]** or **[v]**.
- 4 Press **[PUSH SEL]**, and the clock adjustment screen appears.
For using the remote control, use **[BAND] (SET)**.

5 Adjust the setting value.



[>] : Adjusting minutes

[<] : Adjusting hours

① : Forward

② : Backward



- 6 Press **[PUSH SEL]**, and the menu screen resumes.

For using the remote control, use **[BAND] (SET)**.

- 7 Press **[MENU]** to close the menu screen.

For using the remote control, hold down **[SEL] (MENU)** for 2 sec. or more.

General

This chapter explains how to turn on or off the power, how to adjust the volume, etc.

Power On/off (PWR: POWER)

Power on

Press [**SOURCE**] (PWR: POWER).



Power off

Hold down [**SOURCE**] (PWR: POWER) until you hear a beep, then release it.

You can remove the face plate to prevent it from being stolen.



Removing

1 Turn off the power (→ page 14)

2 Press [**HOME**]
(Release).

(The face plate disengages with a click when it is removed.)



The face plate automatically closes after a lapse of 5 seconds while it is open.

The power is automatically turned off while the unit is active.

3 Put the face plate in the case.

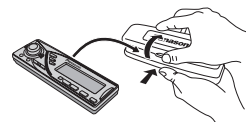

Mounting

1 Slide the left side of the face plate in place.

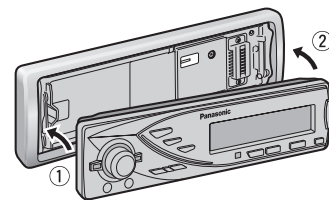

2 Press the right end of the face plate until “click” is heard.

Face Plate Removing/Mounting (ANTI-THEFT SYSTEM)

⚠ Cautions

- It is recommended to remove or mount the face plate when the plate is at the closed position. Do not remove or mount the face plate when the plate is in motion.
- This face plate is not waterproof. Do not expose it to water or excessive moisture.
- Do not remove the face plate while driving your car.
- Do not place the face plate on the dashboard or nearby areas where the temperature rises to high levels.
- Do not touch the contacts on the face plate or on the main unit, since this may result in poor electrical contacts.
- If dirt or other foreign substances get on the contacts, wipe them off with clean and dry cloth.
- To avoid damaging the face plate, do not push it down or place objects on it while it is open.

Open/Eject

Press [**▲OPEN**].

When a disc is already loaded, the disc will automatically be ejected.

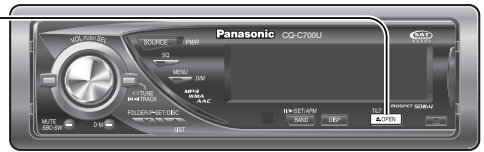
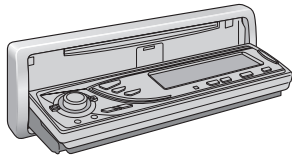

⚠ Cautions

- To avoid damaging the face plate, do not push it down or place objects on it while it is open.
- Do not pinch your finger or hand in the face plate.
- Do not insert foreign objects into the disc slots.
- For the following cases, the face plate automatically closes. Use caution not to catch your finger.
 - After a lapse of 20 seconds
 - When a disc is inserted
 - When the face plate is removed (→ page 14)
 - When ACC is set to off

Close

Press [**▲OPEN**].

Tilt

The display angle changes among 4 levels as follows every time you hold down [**▲OPEN**] (TILT) for 1 sec. or more and release.



Note: The last selected angle is memorized even after turning off the power.

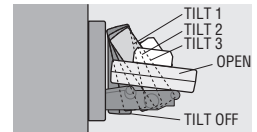

- 1 Up
- 2 Down

Setting Range: 0 to 40
Default: 18

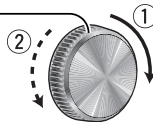

Notes:

- The volume level can be set independently for each source. (For radio, one volume setting for AM, one volume setting for all FMs)
- The volume is not adjustable while an error or the menu screen is present on the monitor.
- This unit memorizes individual volume levels for each source. Make volume adjustments of each source appropriately to prevent large volume fluctuation when the source is changed.

Volume off (down)

Press [**MUTE**].



Cancel

Press [**MUTE**] again.

Note: Volume-down range can be specified. (→ page 29)



The source changes as follows every time [SOURCE] is pressed.

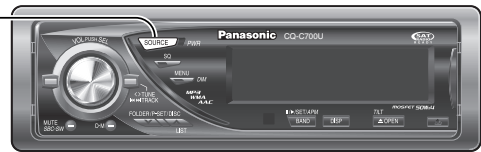

Radio

FM1, FM2, FM3, AM (→ page 20)



Player

When loading CD (→ page 22)



When loading a disc containing compressed audio files (→ page 24)



AUX 1

Device connected to the AUX terminal of the this unit



System-up Connector

Device connected to the System-up Connector of this unit

When optional devices are connected:

Shift to connected devices

When an expansion module is connected:

The devices connected to the ports 1 to 4 are activated in sequence after shifting to AUX2 (devices connected to the AUX terminal of the expansion module).

When connecting DVD Changer



When connecting CD Changer



When connecting iPod



When connecting XM Receiver

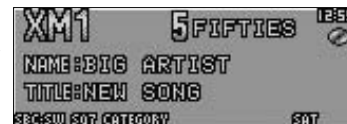

When connecting Sirius Receiver



When connecting Expansion Module



Note: For information about connectable devices, refer to the **System Upgrade Guidebook** or the instruction manual for each device.

Source Selection (SOURCE)

Display Change (DISP: DISPLAY)

The display changes as follows every time [DISP: DISPLAY] is pressed.

Note: The graphic pattern and still image are selectable. (→ page 31)

At power-on:



Folder hierarchy (Compressed Audio Player mode only.)

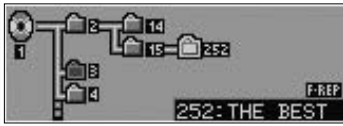

Ordinary display + graphic pattern



Only graphic pattern



Note: The graphic equalizer of 19 bands (S.A.) is selectable when selecting a graphic pattern.

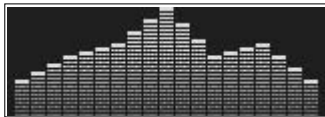

Display OFF

All displays disappear in 5 seconds.



Ordinary display + clock



Only still image



Ordinary display + still image



At power-off:

Clock display (default)

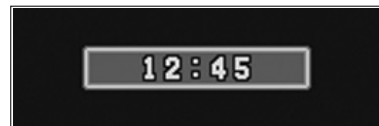

Off



The dimmer level changes as follows every time you hold down [MENU] (DIM: DIMMER) for 2 sec. or more.

Brighter (default)



Medium



Darker



Note: This setting is not adjustable with the remote control.

Dimmer Control (DIM: DIMMER)

Sound Control

SQ Selection Based on Genre (SQ: SOUND QUALITY)

The equalizer curve is selectable from among preset 6 types (FLAT, ROCK, POP, VOCAL, JAZZ, and CLUB) depending on your listening category.

SQ changeover

The SQ category is changed every time **[SQ]** (Sound Quality) is pressed.

Note: Setting of SQ, bass/treble and volume are influenced one another. If the influence mentioned above causes distortion to the audio signal, readjust bass/treble or volume. (→ page 28)



Lights when SQ is activated.

SQ is adjustable in accordance with your taste.

1 Hold down **[SQ]** (Sound Quality) for 2 sec. or more to display "SOUND QUALITY MENU".

2 Press **[PUSH SEL]**.

The targeted SQ preset appears.

For using the remote control, use **[BAND]** (**SET**).

3 Adjust each band.

Band: 60, 160, 400, 1 k, 3 k, 6 k, 16 k (Hz)



[<] [>] : Band selection

① ② : Level up/down

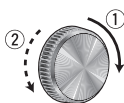

"USER" appears in the category name after adjustment.

Note: If **[PUSH SEL]** is held down for 2 sec. or more on the "SQ ADJUSTMENT" display, the preset data that is called up can be turned into the default.

4 Press **[PUSH SEL]**.

The screen of Step 1 appears again.

For using the remote control, use **[BAND]** (**SET**).

5 Press **[DISP: DISPLAY]**.

The regular screen appears again.

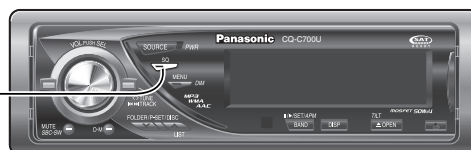

SQ adjustment (USER)

Substitutional Subwoofer

(SBC-SW: SUPER BASS CONTROL-SUBWOOFER)

The rear speaker can be used as a substitutional subwoofer when a subwoofer is not connected.

Holding down [SBC-SW] for 2 sec. or more toggles SBC-SW on and off.



Off (default)



On

Lights when SBC-SW is activated.



Notes:

- If ON is selected, the settings of subwoofer level adjustment and subwoofer low pass filter are activated. (⇒ page 28)

Radio

This chapter explains how to listen to the radio.

Operation Flow

1 Press **[SOURCE]** to select the radio mode.

2 Press **[BAND]** to select a band.



3 Select a station.

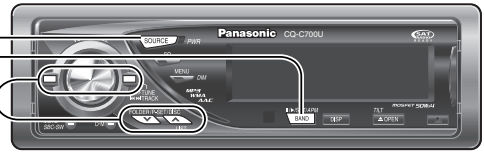

Frequency adjustment

[<] (TUNE): Lower

[>] (TUNE): Higher

Note: Hold down for 0.5 sec. or more and release for station search.

Preset station selection

[V] (P-SET: Preset): Lower preset number

[^] (P-SET: Preset): Higher preset number

Notes:

- Direct selection can be executed with **[1]** to **[6]** buttons on remote control.
- A preset station is selectable by turning **[VOL]** while the preset list screen is present on the monitor.
- The volume is not adjustable while the preset list screen is present on the monitor.

Radio Mode Display

Band

Frequency



Preset Number

Lights while receiving an FM stereo signal.

Direct Memory

You can assign your favorite broadcasting station to the **[D-M]** button. As the result of doing that, your favorite broadcasting station can be received even if the unit is in the CD mode or other modes. (Default: FM 87.9 MHz)

Note: For the use of an FM transmitter, it is useful for users to register applicable frequencies on D-M (Direct Memory).

D-M station Calling

Press **[D-M]** (DIRECT MEMORY).

D-M station Setting

- ① Select a station you would like to preset.
- ② Hold down **[D-M]** (DIRECT MEMORY) for 2 sec. or more.



Note: If the unit is turned off during receiving a broadcasting station via D-M, the unit starts again receiving the broadcasting station via D-M by turning on the unit.

Up to 6 stations can be preset in AM, FM1, FM2, and FM3 respectively.

Preset stations can be simply called up by pressing [**^**] (**P-SET**) or [**V**] (**P-SET**).

Notes:

- Direct selection can be executed with [**1**] to [**6**] buttons on remote control.
- You can switch between 6 and 18 for FM presetting stations. (EACH BAND/ALL BAND)
- Preset stations are changeable. (Preset Swap)

Auto Preset Memory (APM)

Stations with good receiving conditions automatically preset.

- 1 Select a band.
- 2 Hold down [**BAND**] (**APM**) for 2 sec. or more.

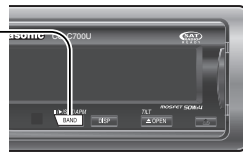

The preset stations under best receiving conditions are received for 5 sec. each after presetting the stations (SCAN). To stop scanning, press [**^**] or [**V**].

Note: New stations overwrite existing saved stations.

Manual station preset

- 1 Tune in to a station.
- 2 Hold down [**^**] or [**V**] for 2 sec. or more.
- 3 Turn [**VOL**] to select a preset number.
- 4 Hold down [**PUSH SEL**] for 2 sec. or more, and the frequency is stored at the selected preset number.

Notes:

- In step 2, a station can be registered by holding down the numeric button [**1**] to [**6**] for 2 sec. or more.
- To stop presetting stations, press [**DISP**] (DISPLAY).
- The operation above allows users to replace the current station with the station preset in the selected number while selecting a preset station. (Preset Swap)

- 1 Press [**MENU**] to display the menu display.

For using the remote control, hold down [**SEL**] (**MENU**) for 2 sec. or more.

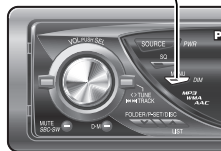

- 2 Press [**PUSH SEL**] to adjust.

For using the remote control, use [**BAND**] (**SET**).

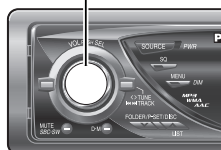

- 3 Press [**MENU**] to close the menu screen.

For using the remote control, hold down [**SEL**] (**MENU**) for 2 sec. or more.

PRESET

Preset range for FM bands

EACH BAND: Individual setting for FM1-3 each (default)

ALL BAND: Setting of FM1-3 together

CD Player

⚠ Cautions

- This unit does not support 8 cm (3") discs.
- Do not use irregularly shaped discs. (→ page 38)
- Do not use discs that have a seal or label attached.
- To avoid damaging the face plate, do not push it down or place objects on it while it is open.
- Do not pinch your finger or hand in the face plate when the face plate is in motion.
- Do not insert foreign matter into the disc slots.
- Refer to the section on "Notes on CD/CD Media (CD-ROM, CD-R, CD-RW)" (→ page 38).
- This unit does not support a MIX mode CD (a CD containing both CD-DA and compressed audio data). In case of using such a CD, problems may occur such as anacoustic playback.

Operation Flow

When a disc is already loaded, press [SOURCE] to select the CD mode.

1 Press [▲OPEN] to open the face plate.

When a disc is already loaded (Ⓛ lights), the disc will automatically be ejected.

2 Load a disc with the printed side facing up.

The face plate closes automatically, and the unit recognizes the disc and starts playing automatically, too.

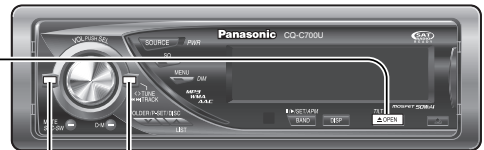
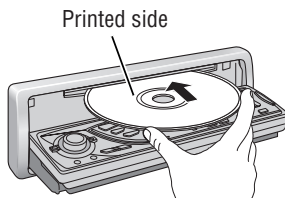

3 Select a desired portion.

Track selection

[▶▶] (TRACK): Next track

[◀◀] (TRACK): Preceding track (press twice)

Note: Hold down for fast forward/reverse.

Pause

Press [BAND] (||▶).

Press again to cancel.

4 Press [▲OPEN] to eject the disc.

Note: The panel automatically closes after 20 seconds.

CD Mode Display

Track number

Time



CD-TEXT display

Notes:

- For scrolling text, hold down [DISP: DISPLAY] for 2 sec. or more.
- "NO TEXT" is displayed when there is no information on the disc.

Play Mode indicators

Lights when each mode is activated.

RANDOM

REPEAT

SCAN

Lights when the disc is loaded.

Random and Repeat play can be set.

- 1 Press **[MENU]** to display the menu display.

For using the remote control, hold down **[SEL] (MENU)** for 2 sec. or more.

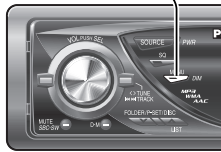

- 2 Turn **[VOL]** to select a function to be adjusted.

For using the remote control, use **[^]** or **[v]**.

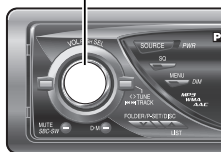

- 3 Press **[PUSH SEL]** to adjust.

For using the remote control, use **[BAND] (SET)**.

- 4 Press **[MENU]** to close the menu screen.

For using the remote control, hold down **[SEL] (MENU)** for 2 sec. or more.



RANDOM

OFF: Off (default)

ON: Random playback

REPEAT

OFF: Off (default)

ON: Playing the current track repeatedly

TEXT (CD-TEXT)

ON: Enabled (default)

OFF: Disabled

Play Mode Selection

One-touch operation is available for selecting a track playing style by use of **[RANDOM]** or **[REPEAT]**.

RANDOM

Press **[RANDOM]**.

Press again to cancel.

REPEAT

Press **[REPEAT]**.

Press again to cancel.

SCAN play

You can find your favorite track by playing first 10-sec. of each track.

Press **[SCAN]**.

Press again to cancel.

Direct Access

A track can be directly selected.

Example: track number 5

1 Press **[#] (NUMBER)**.

2 Press **[5]**.

3 Press **[SET]**.

Note: To suspend direct selection, press **[DISP]** (DISPLAY).



MP3/WMA/AAC Player

This unit can play MP3, WMA, and AAC files.

Operation Flow

When a disc is already loaded, press **[SOURCE]** to select the compressed audio mode.

1 Press **[▲OPEN]** to open the face plate.

When a disc is already loaded (● lights), the disc will automatically be ejected.

2 Load a disc with the printed side facing up

The face plate closes automatically, and the unit recognizes the disc and starts playing automatically, too. (It may take several minutes to start for a disc that has a lot of files.)

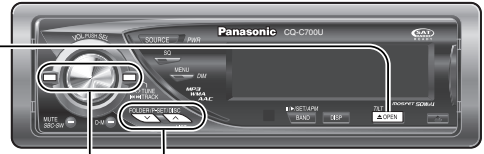
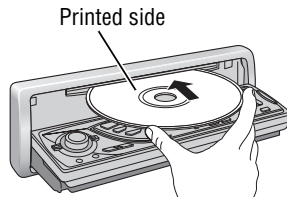

3 Select a desired portion.

Folder selection

[^] (FOLDER): Next folder

[v] (FOLDER): Preceding folder

File selection

[▶▶] (TRACK): Next file

[◀◀] (TRACK): Preceding file (press twice)

Note: Hold down for fast forward/reverse.

Pause

Press **[BAND]** (||/▶).

Press again to cancel.

4 Press **[▲OPEN]** to eject the disc.

Note: The panel automatically closes after 20 seconds.

Compressed Audio Player Mode Display

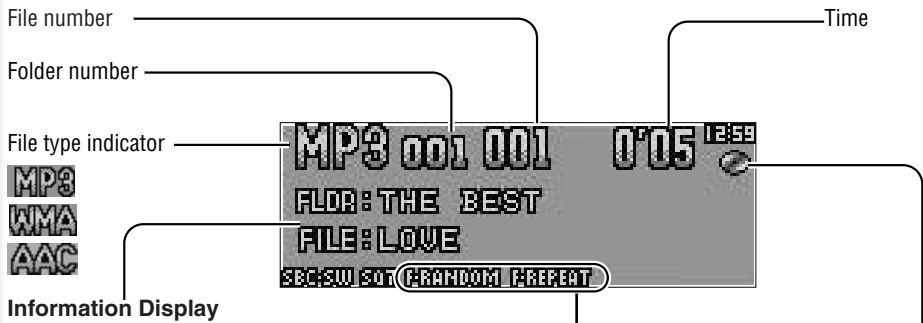

Notes:

- For scrolling text, hold down **[DISP: DISPLAY]** for 2 sec. or more.
- "NO TEXT" is displayed when there is no information on the disc.

Play Mode indicators
Lights when each mode is activated.

RANDOM

REPEAT

SCAN

R:RANDOM (Folder Random)

R:REPEAT (Folder Repeat)

R:SCAN (Folder Scan)

Notes:

- Refer to the pages 26 and 27 for cautions.
- This unit does not support a MIX mode CD (a CD containing both CD-DA and compressed audio files). In case of using such a CD, problems may occur such as anacoustic playback.

Random, Repeat Play (Compressed Audio Player Menu Display)

(RANDOM, REPEAT)

Random and Repeat play can be set.

- 1 Press **[MENU]** to display the menu display.

For using the remote control, hold down **[SEL] (MENU)** for 2 sec. or more.

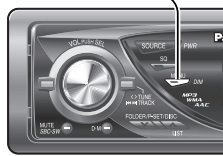

- 2 Turn **[VOL]** to select a function to be adjusted.

For using the remote control, use **[^]** or **[v]**.

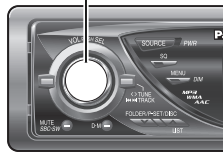

- 3 Press **[PUSH SEL]** to adjust.

For using the remote control, use **[BAND] (SET)**.

- 4 Press **[MENU]** to close the menu screen.

For using the remote control, hold down **[SEL] (MENU)** for 2 sec. or more.



RANDOM

OFF: Off (default)

ON: Random playback (disc)

FOLDER RANDOM

OFF: Off (default)

ON: Random playback (folder)

REPEAT

OFF: Off (default)

ON: Playing the current file repeatedly

FOLDER REPEAT

OFF: Off (default)

ON: Playing the current folder repeatedly.

TEXT

FOLDER/FILE: Folder name/File name (default)

ALBUM/TITLE: Album/Title/Artist (tag information)

OFF: No display

RE-MASTER

The high-range signal lost through MP3/WMA/AAC compression is reproduced to more closely recreate the pre-compressed sound.

Notes:

- At high bit rates, the Re-master function may have little effect.
- The Re-master function is only effective for playback of MP3/WMA/AAC data.

ON: Digital sound enhancer activated (default)

OFF: Digital sound enhancer inactivated

Functions Only by Remote Control Unit

Play Mode Selection

One-touch operation is available for selecting a file playing style by use of **[RANDOM]** or **[REPEAT]**.

RANDOM, REPEAT

Press the button. Press again to cancel.

FOLDER RANDOM, FOLDER REPEAT

Hold down the button for 2 sec. or more. Hold down again to cancel.

SCAN play

You can find your favorite file by playing first 10-sec. of each file.

SCAN (All files)

Press **[SCAN]**. Press again to cancel.

FOLDER SCAN (1st file in each folder)

Hold down **[SCAN]** for 2 sec. or more. Hold down again to cancel.

Direct Access

A file in the current folder can be directly selected.

Example: file number 5

- 1 Press **[#] (NUMBER)**.

- 2 Press **[5]**.

- 3 Press **[SET]**.



Notes:

- For folder selection, enter a number after pressing **[#] (NUMBER)** twice.
- To suspend direct selection, press **[DISP]** (DISPLAY).

Each of MP3 (MPEG Audio Layer-3), WMA (Windows Media™ Audio), and AAC (Advanced Audio Coding) is a format for compressed audio file. These formats allow users to save all the files contained in approximately 10 pieces of existing CDs on one piece of CD-R/RW.

Note: Each of encoding software is not included with this unit.

Setting at file making

Common

- High bit rate and high sampling frequency are recommended for high quality sounds.
- Selecting VBR (Variable Bit Rate) is not recommended because playing time is not displayed properly and sound may be skipped.
- The playback sound quality differs depending on the encoding circumstances. For details, refer to the user manual of your own encoding software and writing software.
- Be sure to put an extension compatible with the format.

MP3

- It is recommended to set the bit rate to “128 kbps or more” and “fixed”.

Compression formats

| Compression method | Bit rate | VBR | Sampling frequency |
|--------------------------------------|-----------------|-----|--|
| MPEG 1 audio layer 3 (MP3) | 32 k – 320 kbps | Yes | 32, 44.1, 48 kHz |
| MPEG 2 audio layer 3 (MP3) | 8 k – 160 kbps | Yes | 16, 22.05, 24 kHz |
| MPEG 2.5 audio layer 3 (MP3) | 8 k – 160 kbps | Yes | 12, 11.205, 8 kHz |
| Windows Media Audio Ver. 2, 7, 8, 9* | 32 k – 192 kbps | Yes | 32, 44.1, 48 kHz |
| MPEG 4 AAC LC | 24 k – 320 kbps | Yes | 8, 11.205, 12, 16, 22.05, 24, 32, 44.1, 48 kHz |

* WMA 9 Professional/LossLess/Voice are not supported.



Caution

Never put an extension indicating compressed audio (such as “.mp3”, “.wma”, and “.m4a”) to files other than compressed audio files. This may not only produce noise from the speaker damage, but also damage your hearing.

Display Information

- **Common**
Folder name,
File name
- **MP3**
Album name,
Title name/artist name
(ID3 tag)
- **WMA**
Album name,
Title name/artist name
(WMA tag)
- **AAC**
Album name,
Title name/artist name
(AAC tag)

standard of each file system. Refer to the instructions of writing software for details.

- ASCII character set and special characters in each language can be displayed.

ASCII character set

A to Z, a to z, digits 0 to 9, and the following symbols:

(space) ! " # \$ % & ' () * + , - . / : ; < = > ? @ [\] ^ _ ` { | } ~

Notes:

- Characters may be garbled depending on encoding software to be used.
- Undisplayable characters and symbols will be converted into an asterisk (*).

Displayable characters

- Displayable length of file name/folder name: within 64 characters. (Unicoded file and folder names are reduced by half in the number of displayable characters.)
- Name files and folders in accordance with the stan-

Compressed audio file writing

- Do not save an audio file (CD-DA file) and a compressed audio file on the same disc. Failure to observe this may result in difficulty in playing.
- If compressed audio files formatted with two or more types are saved on the same disc, each format shall have a different folder.
- Do not write files other than compressed audio files.
- Playability may depend on the combination of writing software and disc writer to be used.
- This unit does not support the play list function.
- Write files in a disc-at-once manner unless otherwise needed.
- You can shorten the duration between data read and playback by decreasing the quantity of files or folders, or the depth of the hierarchy.

Supported file systems

ISO 9660 Level 1/Level 2/Level 3, Joliet, Romeo

Note: Apple HFS, UDF 1.50, Mix CD and CD Extra are not supported.

Folder selection order/file playback order

Maximum number of files/folders

- Maximum number of files: 511 (files + folders)
- Maximum number of files in one folder: 255
- Maximum depth of trees: 8
- Maximum number of folders: 255 (Root folder is included.)

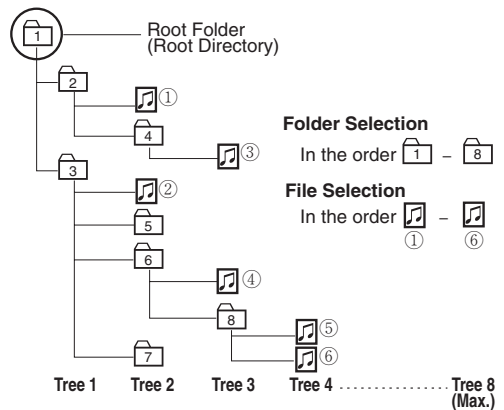

Notes:

- This unit counts the number of folders irrespective of the presence or absence of a compressed audio file.
- If the selected folder does not contain any compressed audio file, the nearest compressed audio file in the order of playback will play.
- Playback order of this unit may be different from that of other compressed audio players even if the same disc is used
- "ROOT" appears when displaying the root folder name.

Copyright

It is prohibited by copyright laws to copy, distribute and deliver copyrighted materials such as music without the approval of copyright holder except enjoying yourself personally.

No warranty

Above description complies with our investigations as of October 2006. It has no warranty for reproducibility and displayability of MP3/WMA/AAC.

iTunes is a trademark of Apple Computer, Inc., registered in the U.S. and other countries/regions.

Windows Media, and the Windows logo are trademarks or registered trademarks of Microsoft Corporation in the United States and/or other countries/regions.



MPEG Layer-3 audio coding technology licensed from Fraunhofer IIS and Thomson.

Audio Setting

Adjustment to each speaker and an optional subwoofer

- 1 Press **[PUSH SEL: SELECT]** to display the AUDIO menu display.

For using the remote control, use **[SEL] (MENU)**.



- 2 Press **[PUSH SEL: SELECT]** to select a mode to be adjusted.

For using the remote control, use **[SEL] (MENU)**.

- 3 Turn **[VOL]** clockwise or counterclockwise to adjust.

For using the remote control, use **[VOL ▲]** or **[VOL ▼]**.

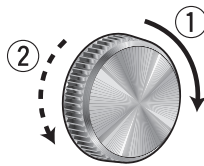

VOLUME

Main volume adjustment

(Setting range: 0 to 40, Default: 18)

- ① : Up
- ② : Down

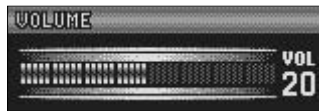

BASS/TREBLE

Bass adjustment

(Setting range: -12 dB to +12 dB, 2 dB Step, Default: Bass 0 dB)

- ① : Up
- ② : Down



BASS/TREBLE

Treble adjustment

(Setting range: -12 dB to +12 dB, 2 dB Step, Default: Treble 0 dB)

- ① : Up
- ② : Down

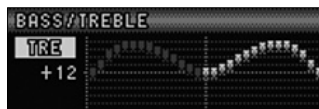

Note: Do not activate SQ and Bass/Treble at same time to avoid causing sound distortion.

BALANCE/FADER

Balance adjustment

(Setting range: L (left) 15 to R (right) 15 and Center, Default: Center)

- ① : Right enhanced
- ② : Left enhanced



BALANCE/FADER

Fader adjustment

(Setting range: R (rear) 15 to F (front) 15 and Center, Default: Center)

- ① : Front enhanced
- ② : Rear enhanced



SUB WOOFER

Subwoofer level adjustment

(Setting range : mute (-∞), -6 dB to +6 dB, 2 dB Step, Default: 0 dB)

- ① : Up
- ② : Down



LPF

Subwoofer Low Pass Filter

(Setting range: 80 Hz, 120 Hz, 160 Hz, Default: 80 Hz)

- ① : Up
- ② : Down

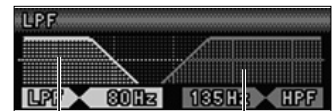

Subwoofer output range

Other speakers output ranges

HPF

High Pass Filter

(Setting range: Filter OFF, 90 Hz, 135 Hz, 180 Hz, 225 Hz, Default: Filter OFF)

- ① : Up
- ② : Down



Function Setting

Adjustment to display on the FUNCTION menu

- 1 Press **[MENU]** to display the menu display.

For using the remote control, hold down **[SEL] (MENU)** for 2 sec. or more.

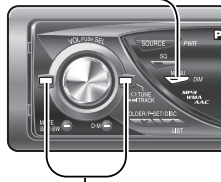

- 2 Press **[<]** or **[>]** to display the FUNCTION menu.



- 3 Turn **[VOL]** to select a function to be adjusted.

For using the remote control, use **[^]** or **[v]**.

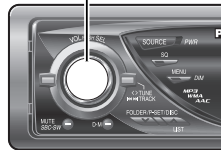

- 4 Press **[PUSH SEL]** to adjust.

For using the remote control, use **[BAND] (SET)**.

- 5 Press **[MENU]** to close the menu screen.

For using the remote control, hold down **[SEL] (MENU)** for 2 sec. or more.

MUTE KEY

Setting **[MUTE]** buttons' functions

- MUTE** : Volume off (Default)
- ATT LW 1** : Volume down by 10 steps
- ATT LW 2** : Volume down by 5 steps

SECURITY

Setting the security function (⇒ page 13)

- ON** : ON (Default)
- OFF** : OFF

BUILT-IN AMP

You can toggle the integrated amplifier on and off.

- ON** : Amplifier on (Default)
- OFF** : Amplifier off (when the external amplifier is used)



Lights when deactivated.

Display Setting

Adjustment to display on the DISPLAY menu

- 1 Press **[MENU]** to display the menu display.

For using the remote control, hold down **[SEL] (MENU)** for 2 sec. or more.

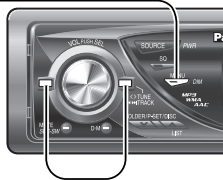

- 2 Press **[<]** or **[>]** to display the DISPLAY menu.



- 3 Turn **[VOL]** to select a function to be adjusted.

For using the remote control, use **[^]** or **[v]**.

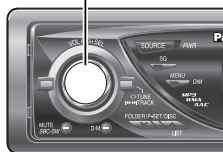

- 4 Press **[PUSH SEL]** to adjust.

For using the remote control, use **[BAND] (SET)**.

- 5 Adjust the setting value.

- 6 Press **[PUSH SEL]**.

For using the remote control, use **[BAND] (SET)**.

- 7 Press **[MENU]** to close the menu screen.

For using the remote control, hold down **[SEL] (MENU)** for 2 sec. or more.

DEMONSTRATION

Switching by **[PUSH SEL]**.

- ON:** Demonstration screen at no operation (default)
- OFF:** Regular screen

GRAPHIC PATTERN

(Default: All)

Turn **[VOL]** to make a selection.

All: Sequential display from pattern A to C.

Pattern A-C

S.A.: 19-band display (Spectrum analyzer)



STILL IMAGE PATTERN

(Default: All)

Turn **[VOL]** to make a selection.

All: Sequential display from pattern 1 to 10

No.1-10



CONTRAST

(Setting range: 1 to 5, Default: Contrast 3)

① : Tilting up view angle

② : Tilting down view angle



CLOCK ADJ

Note: Adjust the clock when "ADJUST" appears on the display.

[>] : Adjusting minutes

[<] : Adjusting hours

① : Forward

② : Backward



Notes:

- The graphic pattern and still image are changeable. (⇒ page 31)
- If corrupted data is selected, "DISPLAY FILE INCOMPLETE" appears. (⇒ page 32)

Customize the Display (Customize Function)

You can edit the moving images and still images that are initially stored in the unit. You also can use the data that is downloaded from the Panasonic Web site and the data that is stored with a digital camera or other devices and processed with exclusive software, IMAGE STUDIO. See “Notes on Customize Function” (→ page 32) as well.

Note: Visit Panasonic Web site (<http://panasonic.co.jp/pas/en/software/customize/index.html>) for details.

Preparation:

Put the CD-R/RW that contains data to be customized in hand.

1 If there is a disc inside, take out the disc.

2 Press **[SOURCE]** to select the CD mode.

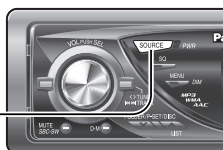

3 Hold down **[PUSH SEL]** for 4 sec. or more to display the menu screen.

CUSTOMIZE MENU

4 Load a CD-R/RW that contains data.

Notes:

- It may take time for the unit to identify the CD-R/RW.
- Discs recorded by the packet writing software are not supported.

5 Select an item to be customized.



1 2 : Select
[PUSH SEL]: Confirm

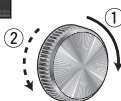

Note: To exit the customize menu, hold down **[PUSH SEL]** for 4 sec. or more.

GRAPHIC PATTERN

Moving image (graphic pattern) data (→ page 30)

STILL IMAGE

Still image data (→ page 30)

OPENING MESSAGE

Moving image at power on

CLOSING MESSAGE

Moving image at power off

6 Select a file.



1 2 [<I>]: Select
[PUSH SEL]: Confirm

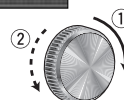

Notes:

- Files are automatically identified by their extensions, and target files are displayed.
- If “**BACK**” is selected, the screen of step 5 appears.

7 For a moving image file or still image file, select where to save the file.



1 2 [A|V]: Select
[PUSH SEL]: Confirm



Notes:

- New data overwrites existing data.
- If “**BACK**” is selected, the screen of step 6 appears.

8 Confirm the changed item.

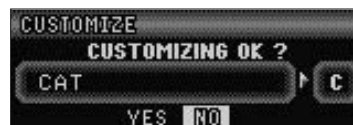

1 2 : Select
[PUSH SEL]: Confirm



CUSTOMIZING COMPLETE

Customization is performed. Do not turn off the power in mid-operation. (It takes approx. 1 minutes to complete this operation for a 168 kB moving image.) After completion of this operation, the screen of step 5 appears.

Note: If “**NO**” is selected, the screen of step 5 appears.

9 Press **[▲OPEN]** to eject the disc.

10 Hold down **[PUSH SEL]** for 4 sec. or more.

The CD mode comes back.

Note on Download Service

The download service may be suspended or stopped without advance notice. The download service is not available in some areas. Please visit the site below for further information.

Panasonic Web site:
(<http://panasonic.net>)

Notes on IMAGE STUDIO

- This download service is not available in some areas. For details, please access the Panasonic website.
- IMAGE STUDIO is available only by downloading from the address below. It is not bundled with this unit.
- Refer to the downloaded operating manual for how to use IMAGE STUDIO.

Notes on File

- The customize-specific file is downloadable from the URL below. You can create exclusive files stored with a digital camera or other devices by using exclusive software, IMAGE STUDIO that can be accessed from the same URL.
- Do not change the extension. Otherwise, the data cannot be recognized.

At Disc Making

- Save only customize-specific data.
- Save all data in the root directory. Files contained in a folder cannot be recognized.
- Follow the table below with regard to the number of files that are saved to a disc. Files beyond the specified capacity are not readable.
- Discs recorded by the packet writing software are not supported.

| Type | Extension | Max. number |
|-----------------|-----------|-------------|
| GRAPHIC PATTERN | .pfm | 10 |
| STILL IMAGE | .pfs | 15 |
| OPENING MESSAGE | .pfo | 5 |
| CLOSING MESSAGE | .pfe | 5 |

At Customizing

- If customizing is interrupted on account of turning off the power, stopping the engine, removing the face plate or other reasons, you may lose the data. In such a case, try customizing again.
- The default image exists on the Panasonic Web site. If you would like to restore it, download the image from the site.

Download site:

<http://panasonic.co.jp/pas/en/software/customize/index.html>

Error Display Messages

NO FILES DETECTED

No customize-specific data on the disc

- ➔ **Load a disc that contains customize-specific data.**

CUSTOMIZING FAILED

Customize failed

- ➔ **Check to see whether or not the extension is correct and file contents are appropriate.**

DISPLAY FILE INCOMPLETE

Intended moving image or still image is damaged.

- ➔ **Customize it again and overwrite the file with new one.**

Troubleshooting

If You Suspect Something Wrong

Check and take steps as described below.

If the described suggestions do not solve the problem, it is recommended to take the unit to your nearest authorized Panasonic Servicenter. The product should be serviced only by qualified personnel. Please refer the checking and the repair to professionals. Panasonic shall not be liable for any accidents arising out of neglect of checking the unit or your own repair after your checking.

Never take measures especially for those other than indicated by *italic* letters in "Possible Solution" described below because those are too dangerous for users to handle themselves.

Warning

- Do not use the unit in an irregular condition, for example, without sound, or with smoke or a foul smell, which can cause ignition or electric shock. Immediately stop using the unit and consult your dealer.
- Never try to repair the unit by yourself because it is dangerous to do so.

Common

| Problem | Possible cause → Possible solution |
|---|--|
| <p>No power to the unit</p> | <p>The power cord (battery, power and ground) is connected in the wrong way. → Check the wiring.</p> <p>Fuse blows out. → Eliminate the cause of fuse blowout and replace the fuse with new one. Consult your dealer.</p> |
| <p>Sound is not generated.</p> | <p>MUTE is set to ON. → Set MUTE to OFF.</p> <p>The wiring of speaker lines are not correct, or a break or poor contact arises. → Check the wiring in accordance with the wiring diagram. (Installation Instructions)</p> |
| <p>Noise</p> | <p>There is an electromagnetic-wave generator such as a cellular phone near the unit or its electrical lines. → Keep an electromagnetic-wave generator such as a cellular phone away from the unit and the wiring of the unit. In case that noise cannot be eliminated due to the wiring harness of the car, consult your dealer.</p> <p>The contact of the ground lead is poor. → Make sure that the ground lead is connected to an unpainted part of the chassis securely.</p> |
| <p>Noise is made in step with engine revolutions.</p> | <p>Alternator noise comes from the car. → Change the wiring position of the ground lead. → Mount a noise filter on the power supply.</p> |

English

Customize the Display, Troubleshooting

Troubleshooting (continued)

Common (continued)

| Problem | Possible cause → Possible solution |
|--|--|
| Some operations are not executable. | Some operations are not executable in particular modes such as menu mode. → Read the operating instructions carefully and cancel the mode. If the unit is still out of order, consult your dealer. |
| No sound from speaker(s) | BALANCE/FADER setting is not appropriate. → Readjust BALANCE/FADER. There is a break, a short circuit, poor contact or wrong wiring regarding the speaker wiring. → Check the speaker wiring. |
| The speaker channels are reversed between right and left. | The speaker wiring is confused between right and left. → Perform the speaker wiring in accordance with the wiring diagram. |
| The sound field is not clear in the stereo mode. Central sound does not settled. | The plus and minus terminals at right and left channels of speakers are connected reversely. → Perform the speaker wiring in accordance with the wiring diagram. |
| The power fails unintentionally. | The safety device works. → Consult your dealer, or your nearest Panasonic Servicenter. |

Radio

| | |
|--|---|
| Poor reception or noise | Antenna installation or wiring of antenna cable is faulty. → Check whether the antenna mounting position and its wiring are correct. In addition, check to see whether the antenna ground is securely connected to the chassis. No power is supplied to the antenna amplifier (when using a film antenna, etc.). → Check the wiring of the antenna battery lead. |
| The number of auto preset stations is less than 6. | The number of receivable stations is less than 6. → Move to an area where receivable stations number is maximum, and try pre-setting. |
| Preset stations cannot be stored. | The contact of the battery lead is poor, or the battery lead is not always powered. → Make sure that the battery lead is connected securely, and preset stations again. |

CD

| Problem | Possible cause → Possible solution |
|---|--|
| <p>No playback or disc ejected</p> | <p>The disc is inserted upside down. → Insert a disc correctly.</p> |
| | <p>There is a flaw or foreign material on the disc. → Remove the foreign material, or use a flawless disc.</p> |
| <p>Sound skipping or noise</p> | <p>There is a flaw or foreign material on the disc. → Remove the foreign material, or use a flawless disc.</p> |
| <p>Sound skipping due to vibration</p> | <p>The unit is not sufficiently secured. → Secure the unit to the console box.</p> |
| | <p>The unit is tilted at over 30° in the front-to-end direction. → Make the angle 30° or less.</p> |
| <p>Disc unejectable</p> | <p>Something such as a peeled label obstructs the disc coming out. → Press and hold the [▲OPEN] for more than 2 seconds when the face plate is open (disc forced ejection). In case that the disc forced ejection does not work, consult your dealer.</p> |
| | <p>The microcontroller in the unit operates abnormally due to noise or other factors. → Unplug the power cord and plug it again. In case the unit is still out of order, consult your dealer.</p> |

Compressed audio

| | |
|--|---|
| <p>No playback or disc ejected</p> | <p>The disc has unplayable formatted data. → Check the file format.</p> |
| <p>The CD-R/RWs that are playable on other devices are not playable on this unit.</p> | <p>The playability of some CD-R/RWs may depend on the combination of media, recording software and recorder to be used even if these CD-R/RWs are playable on other devices such as a PC. → Make CD-R/RWs in different combination of media, recording software and recorder after referring to the description about the compressed audio player.</p> |
| <p>Sound skipping or noise</p> | <p>There is a flaw or foreign material on the disc. → Remove the foreign material, or use a flawless disc.</p> |
| | <p>Playing VBR (Variable Bit Rate) files may cause sound skipping. → Play Non-VBR files.</p> |
| <p>Noise is heard with "RE-MASTER" at "ON"</p> | <p>With some CDs, noise may be heard in the treble range when playing compressed audio files into which the CD tracks were encoded with "RE-MASTER" enabled. → If noise is heard, set "RE-MASTER" to "OFF".</p> |

Remote control unit

| Problem | Possible cause → Possible solution |
|---|--|
| <p>No response to pressing buttons</p> | <p>The battery is inserted in the wrong direction. A wrong battery is inserted. → <i>Insert a correct battery in the correct direction.</i></p> |
| | <p>The battery is weak. → <i>Replace the battery with new one.</i></p> |
| | <p>The aiming direction of the remote control unit is wrong. → <i>Aim the remote control unit at the sensor of the unit and press buttons.</i></p> |
| | <p>The sensor is exposed to direct sunlight. (The remote control unit may not be operable when the sensor is exposed to direct sunlight. In such a case, the system is not faulty.) → <i>Block off sunlight to the sensor.</i></p> |

Error Display Messages

| | | Display | Possible cause → Possible solution |
|---------------------|--|---|--|
| CD/Compressed Audio | | CD E 1 | <p>The disc is dirty, or is upside down. → Check the disc.</p> <p>The disc has scratches. → Check the disc.</p> |
| | | CD E 3 | <p>No operation by some cause. → Unplug the power cord and plug it again. In case the unit is still out of order, consult your dealer. (→ Installation Instructions)</p> |
| | | CD E 4 | <p>The player for some reason cannot read the file you are trying to play. (File recorded in an unsupported file system, compression scheme, data format, file name extension, damaged data, etc.) → Select a file that the player can read. Check the type of data recorded on the disc. Create a new disc if necessary.</p> |
| | | PROTECTED (After 5 seconds) ↓ To next file automatically | <p>A WMA file can be copyrighted. → The file protected by copyright is not playable.</p> |
| | | NO DISC | No disc. |

Note: Refer to the **System Upgrade Guidebook** for error messages regarding optional products.

Notes on Discs

Notes on CD/CD Media (CD-ROM, CD-R, CD-RW)

If you use commercial CDs, they must have either of these labels shown at right. Some copy-protected music CDs are not playable.



How to hold the disc

- Do not touch the underside of the disc.
- Do not scratch on the disc.
- Do not bend the disc.
- When not in use, keep the disc in a case.



Do not leave discs in the following places:

- In direct sunlight
- Near car heaters
- Dirty, dusty and damp areas
- On seats and dashboards



Labels created by a printer, Protective films or sheets, Irregularly shaped discs

Disc cleaning

Use a dry, soft cloth to wipe from the center outward.



Do not write on the disc label with a ballpoint pen or other hard-point pens.



Disc with adhered stickers or tape

Discs with cracks, scratches or parts missing

Notes on CD-Rs/RWs

- You may have trouble playing back some CD-R/RW discs recorded on CD recorders (CD-R/RW drives), either due to their recording characteristics or dirt, fingerprints, scratches, etc. on the disc surface.
- CD-R/RW discs are less resistant to high temperatures and high humidity than ordinary music CDs. Leaving them inside a car for extended periods may damage them and make playback impossible.
- Some CD-R/RWs can not be played back successfully thanks to incompatibility among writing software, a CD recorder (CD-R/RW drive) and the discs.
- This player cannot play the CD-R/RW discs if the session is not closed.
- This player cannot play the CD-R/RW discs which contains other than CD-DA or compressed audio data.
- Be sure to observe the instructions of CD-R/RW disc for handling it.

Maintenance/Fuse

Cleaning the Unit

Your product is designed and manufactured to ensure the minimum of maintenance. Use a soft cloth for routine exterior cleaning. Never use benzine, thinner, or other solvents.

Fuse

If the fuse blows out, consult your dealer, or your nearest authorized Panasonic Servicenter.

Warning

- Use fuses of the same specified rating (**15 A**). Using substitutes or fuses with higher ratings, or connecting the unit directly without a fuse could cause fire or damage to the unit. **If the replaced fuse fails, contact your nearest authorized Panasonic Servicenter.**

Specifications

General

| | |
|------------------------------------|---|
| Power Supply | DC 12 V (11 V – 16 V), Test Voltage 14.4 V, Negative Ground |
| Tone Controls (Bass/Treble) | Bass; ± 12 dB at 60 Hz, Treble; ± 12 dB at 16 kHz |
| Equalizer Center Frequency | 60, 160, 400, 1 k, 3 k, 6 k, 16 k Hz |
| Variable Range of Equalizer | -12 dB to 12 dB (2 dB step) |
| Current Consumption | Less than 2.2 A (CD mode, 0.5 W 4-Speaker) |
| Maximum Power Output | 50 W x 4 (at 1 kHz) |
| Speaker Impedance | 4 – 8 Ω |
| Pre-amp output voltage | 5 V, (CD mode, 1 kHz, 0 dB) |
| Subwoofer-output voltage | 5 V, (CD mode, 1 kHz, 0 dB) |
| Pre-amp output impedance | 60 Ω |
| Subwoofer-output impedance | 60 Ω |
| Dimensions (Main Unit) | 178(W) x 50(H) x 155(D) mm {7" x 1 ¹⁵ / ₁₆ " x 6 ¹ / ₈ "} |
| Weight (Main Unit) | 1.6 kg {3 lbs. 8 oz} |

CD Player

| | |
|----------------------------------|------------------------------|
| Sampling Frequency | 8 times oversampling |
| DA Converter | 4 DAC System |
| Pick-Up Type | Astigma 3-beam |
| Light Source | Semiconductor laser |
| Wavelength | 790 nm |
| Frequency Response | 20 Hz – 20 kHz (± 1 dB) |
| Signal to Noise Ratio | 96 dB |
| Total Harmonic Distortion | 0.01 % (1 kHz) |
| Wow and Flutter | Below measurable limits |
| Channel Separation | 85 dB |

Stereo Radio

| | |
|--------------------------------------|--------------------------------------|
| FM | |
| Frequency Range | 87.9 MHz – 107.9 MHz |
| Usable Sensitivity | 10.2 dBf (0.9 μ V, 75 Ω) |
| 50 dB quieting Sensitivity | 15.2 dBf (1.6 μ V, 75 Ω) |
| Frequency Response | 30 Hz – 15 kHz (± 3 dB) |
| Alternate channel selectivity | 75 dB |
| Stereo Separation | 30 dB (at 1 kHz) |
| Image response ratio | 55 dB |
| IF response ratio | 100 dB |
| Signal to noise ratio | 62 dB |
| AM | |
| Frequency Range | 530 kHz – 1 710 kHz |
| Usable Sensitivity | 27 dB/ μ V (S/N 20 dB) |

Power Output:
18 W RMS x 4 Channels at 4 Ω and $\leq 1\%$
THD+N
Signal to Noise Ratio:
85 dBA (reference: 1 W into 4 Ω)



Above Specifications comply with EIA standards.

Notes:

- Specifications and design are subject to modification without notice due to improvements.
- Some figures and illustrations in this manual may be different from your product.

**Panasonic Consumer
Electronics Company,
Division of Panasonic
Corporation of North America**
One Panasonic Way, Secaucus,
New Jersey 07094
<http://www.panasonic.com>

**Panasonic Sales Company,
Division of Panasonic Puerto
Rico, Inc. ("PSC")**
Ave. 65 de Infanteria, Km. 9.5
San Gabriel Industrial Park,
Carolina, Puerto Rico 00985
<http://www.panasonic.com>

Panasonic Canada Inc.
5770 Ambler Drive,
Mississauga, Ontario
L4W 2T3
<http://www.panasonic.ca>

YFM264C088CA

PTW1107-1127

Printed in China
Imprimé en Chine
Impreso en China